

产品规格书

Specification

产品名称 (Product): 10.1 寸液晶显示模组/10.1inch TFT LCD Module

驱动板 (Driver board): PT80M03

版本号 (Version): VER: 1.00

液晶屏 (TFT LCD): HB101-24B

客户名称 (Customer): _____

客户型号 (Cust.P/N): _____

日期 (Date): _____

客户 CUSTOMER			承制方 MANUFACTURER		
品质 Quality	工程 Engineer	审批 Approved	审核 Checked	批准 Approved	销售 Sales

目 录 Contents

目 录 Contents.....	2
版本 Version.....	3
1. 概 况 Profile.....	4
2. 基本参数 Specifications.....	4
3. 产品图片 Product Picture.....	5
4. 连线示意图 Wiring Diagram.....	5
5. 驱动板接口定义 Interface Definition.....	6
6. 结构图 Structure.....	7-8
7. 产品标示 Labels.....	9
8. 包装运输 Packing Shipping.....	9
9. PT80M03 调试注意事项 Notes.....	9
10.10.1"TFT- LCD PANEL 判定标准 Judgment.....	10-12

1. 概况 Profile:

PT80M03 VER:1.00-HB101-24B 彩色数字驱动模组，由 PT80M03 VER:1.00 驱动板和 (HB101-24B)屏组成。输入 CVBS、VGA 信号,有 PAL 制和 NTSC 两种制式，可实现自动识别。按键调节，OSD 菜单显示。它主要用于可视电话，也可用于其他显示电子设备。

PT80M03 VER:1.00- HB101-24B Color TFT LCD Module is composed by PT80M03 Driver Board Ver:1.00 and 8" Digital Panel(HB101-24B). This driver board can with VIDEO、VGA signal input, it adopts the backlight of LED, Two system formats, PAL and NTSC (auto switch). Key-press adjustment, OSD menu display. It can use for video door phone, or other electronic display equipment.

2. 基本参数 Specifications:

No.	项目/Item	说明/Description	备注/Note
1	液晶屏显示尺寸/LCD Display	10.1 英寸/10.1inch	
2	显示比例/Display Ratio	16:9	
3	背光方式/Backlight	LED	
4	亮度/Brightness	250±20 cd/m ²	
5	解析度/Resolution	1024×3(RGB)×600	
6	视角范围 View angle	(50/70/70/70) up/down/left/right	
7	液晶屏尺寸/LCD dimension	235(W)×143.0(H)×5.1(D)mm	
8	有效显示范围/Effect area	222.72(W)×125.28(H)×mm	
9	驱动板尺寸/Driver board size	80.0 (W) × 60.0 (H) × 6.8 (D)	
10	工作电压 (纹波小于 0.3VP-P) Working Voltage (Wave<0.3VP-P)	最小: DC9V; 标准: DC12V; 最大: DC15V; Min:DC9V; Standard: DC12V; Max: DC15V;	
11	工作电流 (DC 12V 供电时) Working Current (DC 12V supply)	DC290mA±20mA	
12	消耗功率/Power Consumption	3.48W (TYP)	
13	启动时间/Start Time	≤2.5 秒 ≤2.5s	
14	工作温度范围/Working Temp.	0°C~60°C	
15	储存温度范围/Storage Temp.	-20°C~70°C	
16	环境相对湿度/ENV. Humidity	5~95%RH	

3. 产品图片/Product Picture:



4. 连线示意图/Wiring Diagram:

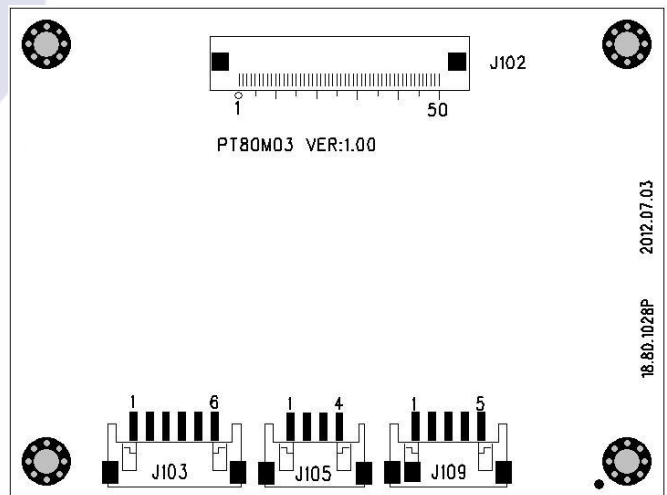
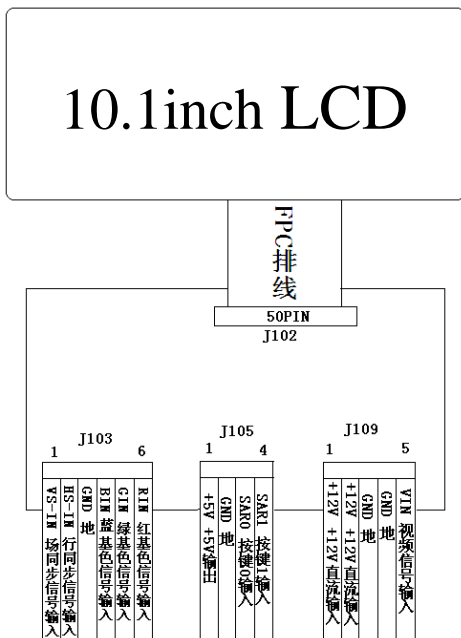

5. 驱动板接口定义/Interface Definition:

5.1. J109 接口定义/J109 Interface Definition:

PIN	Function	I/O/P	脚位定义说明/PIN Definition	Note
1	+12N	I	直流电输入/DC12V power input	
2	+12N	I	直流电输入/DC12V power input	
3	GND	P	地/ Ground	
4	GND	P	地/ Ground	
5	VIN	I	视频信号输入/Video Signal input	

5.2. J103 接口定义/J103 Interface Definition:

PIN	Function	I/O	脚位定义说明/PIN Definition	Note
1	VS-IN	I	场同步信号输入/ Field sync signal input	
2	HS-IN	I	行同步信号输入/ Line sync signal input	
3	GND	P	地/ Ground	
4	BIN	I	蓝基色信号输入/ Blue primary color signal input	
5	GIN	I	绿基色信号输入/ Green primary color signal input	
6	RIN	I	红基色信号输入/ Red primary color signal input	

5.3. J105 接口定义/J105 Interface Definition:

PIN	Function	I/O	脚位定义说明/PIN Definition	Note
1	+5V	O	+5V 输出/+5V OUTPUT	
2	GND	P	地/ Ground	
3	SAR0	I	按键 0 输入/ Key-press 0 input	
4	SAR1	I	按键 1 输入/ Key-press 1 input	

5.3.1. 按键板接线图/Wiring Diagram of keypad:

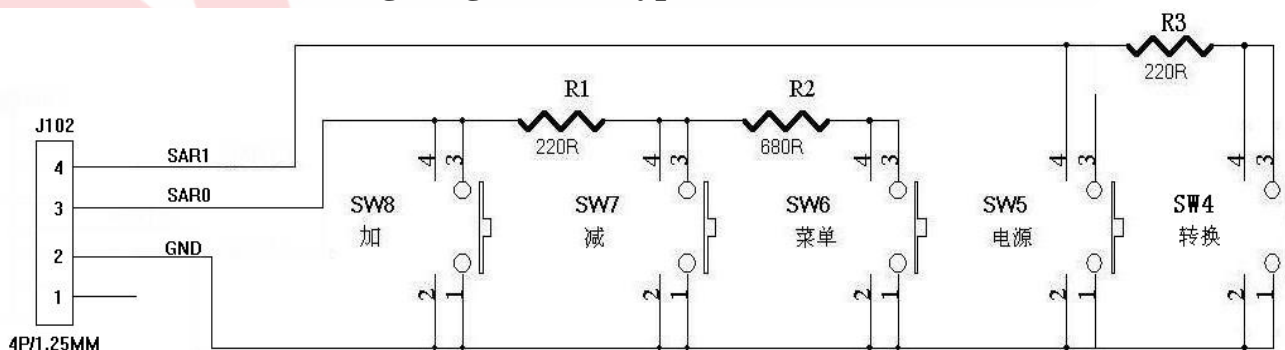

6. 结构图/Structure:

6.1. TFT LCD Panel:

1. Drawing of Up Cover :
模组图:

未注公差: ±0.3

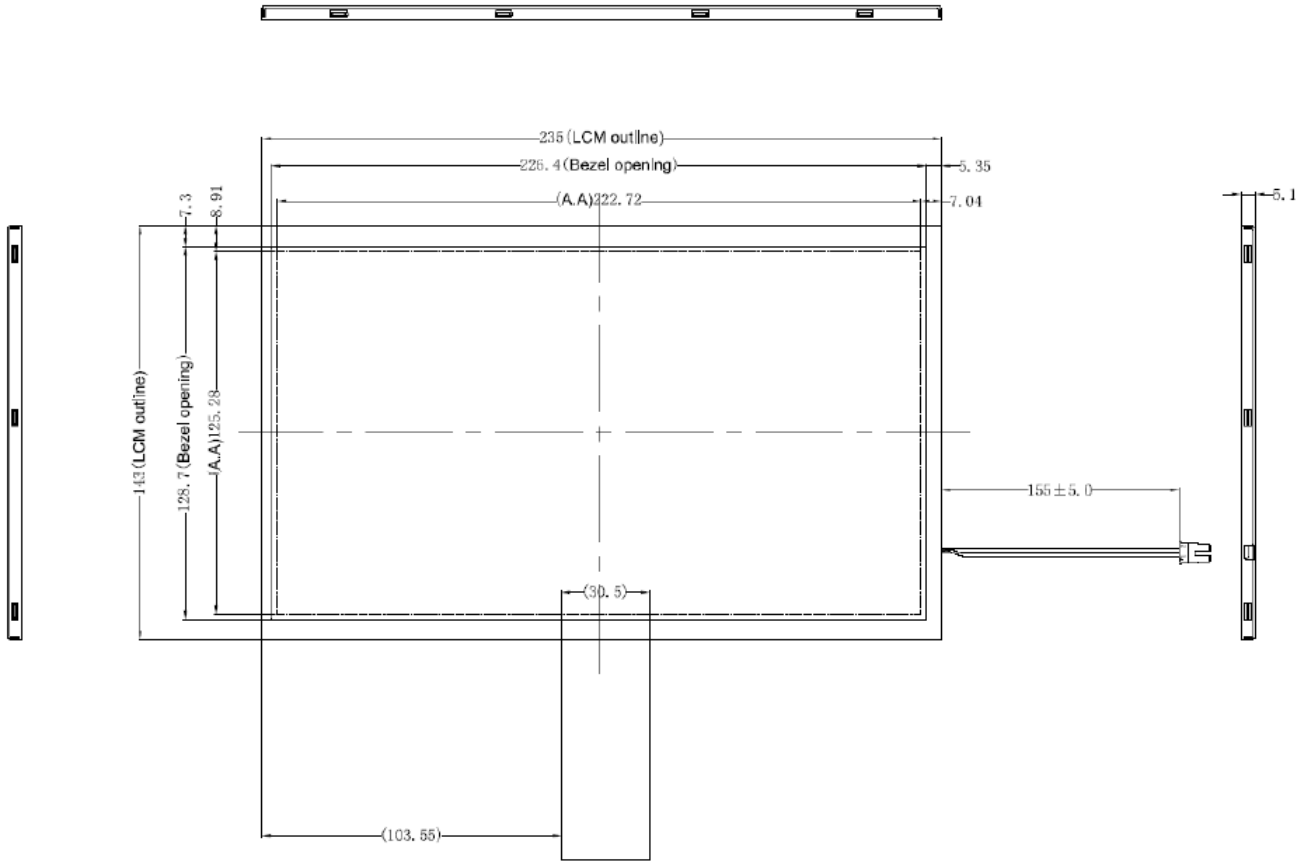

6.2. PCB 尺寸/PCB size: 80.0(W)×60.0(H) ×6.8(D)mm

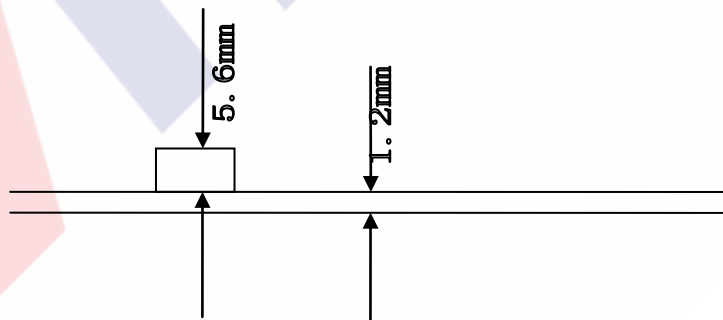
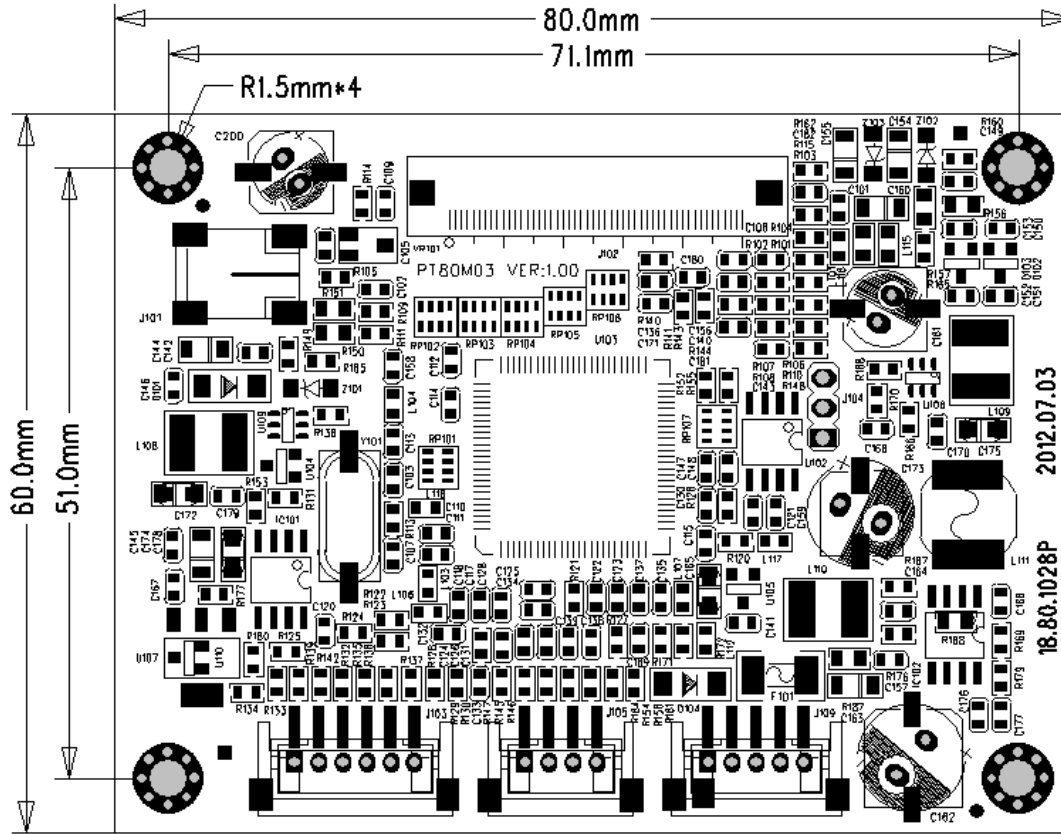

7. 产品标示/Product Label:

B101-24B

8. 包装、运输及贮存/Packing Shipping

8.1. 供货包装/Packing

TBD

8.2. 运输及贮存/Shipping

运输过程避免碰撞和雨雪淋袭；严禁与化学物品及潮湿物品同库贮存。

Don't hit and rain when transportation: Don't storage with chemic goods and wet goods together.

9. PT80M03 调试注意事项/Notes

9.1. TFT 出厂前已用专用仪器进行精密调试和老化、测试，一般不需要再做调整。

TFT have used by special instrument to adjust precision and aging, test before leave factory, no need adjust again.

9.2. 调整前，应正确连接电源、视频信号，应数次开关电源以及视频信号检查图像情况。

Please correctly connect power, video signal before you adjust, should be on/off power and video signal to check the image's effect.

9.3. 因为此产品为电子产品，请注意防静电。

Due to this product is electronic product, please notice prevent static.

9.4. 10.1" TFT- LCD PANEL 为玻璃制品，小心拿放，以免破裂。

10.1" TFT-LCD Panel is a glasswork, place carefully ,broken for fear

9.5. 按按键时需注意不能让手碰到按键引脚，因人体有一定的电阻，如触摸到会对按键功能造成影响。

Don't touch pushbutton's pin feet when you adjust potentiometers, due to person have resistance, you will effect pushbutton's function when touch it.

10. 10.1" TFT- LCD PANEL 判定标准/Judgment:

目的: 制定 PANEL 的标准供进料检查、制程检查、客户检查的依据.

Aim: Make the panel standards to material purchasing, process inspecting and customer checking.

范围: 适用于 10.1" TFT LCD 产品.

Ranges: apply to 10.1" TFT LCD modules

作业内容/ Determinant standard and method:

10.1. 判定标准及方法:

Judgment standard and method:

10.1.1. LCD 显示屏伤痕检测方法 with 判定:

The method and determinant of inspecting the nick of panel of LCD:

在 20W 萤光灯下, 距离 PANEL 30CM 处垂直 (或左、右 45 度) 观察, 如果没有看见异物、伤痕, 则判定 OK, 否则 NG.

Inspect vertically (or at 45 °angle from left/right) under the light tube (the power is 20 W) in the distance of 30cm to the panel. If there is no nick, it determines "OK", otherwise "NG".

10.1.2. LCD 显示屏黑点, 白点, 色点检测方法 with 判定:

The method and determinative for black & white & color spots for the Panel of LCD:

1. 检查方法/Inspection Method:

黑点: 在表示点灯状况下, 把检查黑点的 MASK 摆在 LCD 黑点的附近, 目视观察比较大小.

Black spots: under the situation of "turn on the light", set the MASK of black spot inspection near the black spot then compare the big and small by eyes.

白点, 色点: 在表示点灯状况下, 把检查黑点的 MASK 重叠在 LCD 白点 (色点) 处, 目视观察判断白点 (色点) 否可以隐藏.

White & Color spots: under situation of "turn on the light", set the Mask of black spot inspection on the white spot (or color spot) then observe them by eyes if it can hide.

2. 显示屏区域划分/Division of LCD Panel:

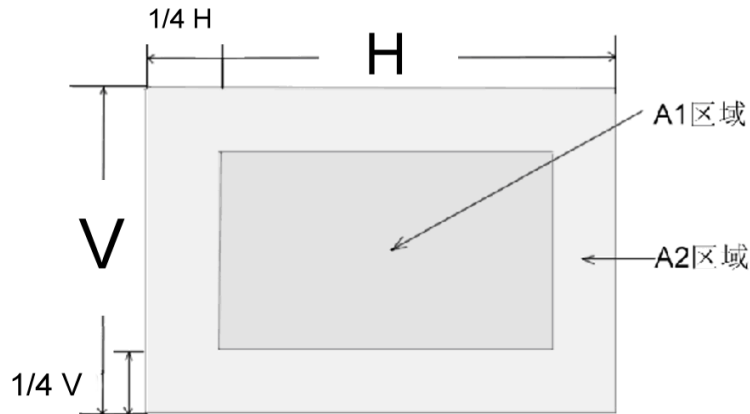

注/Note: A1 区域: 图像有效区域中心范围。

A1 area: The center of the available area for the picture

A2 区域: 图像有效区域边缘范围 (四周的区域)。

A2 Area: The edge of the available area for the picture

10.2. 判定选择/Judgment:

欠点直径 (mm) Spot Diameter		允收范围/Accept Range	
		A1 区域/A1 area	A2 区域/A2 area
黑点 Black spot	$d \leq 0.15$	不计/Disregard	不计/Disregard
	$0.15 < d \leq 0.3$	4	4
	$0.3 < d \leq 0.5$	2	3
	$0.5 < d < 0.8$	0	2
白点或色点 White spot or Color spot	$d \leq 0.15$	不计/Disregard	不计/Disregard
	$0.15 < d \leq 0.3$	3	3
	$0.3 < d \leq 0.5$	1	2
	$0.5 < d < 0.8$	0	1

注/Note:

1. 大小: 平均直径= (最长直径+最小直径) /2

Size: Average Diameter= (Max. Diameter + Min. Diameter) /2

2. 关于小欠点密集的时候, 用上述的基准判断。

Using information above as a standard in order to judge while the e spots are dense.

3. 黑斑、白斑: 通过电压的变化来看, 用对比的方法, 对于明显斑点用点规格判断。

Black & White spot: To judge the obvious spots through the change of voltage by comparison.

4. 总的黑点、白点、色点个数: A1+A2 区 ≤4 个。

Total quantity of Black & white & color spot: A1+A2 ≤4.