

产品规格书
Specification产品名称 (Product) 摄像头模组 Camera Module摄像头 (Camera Module): JDPC70 (CVBS)版本号 (Version): 1.00镜头 (Lens): 3.6mm (650nm)

客户名称 (Customer): _____

客户型号 (Cust.P/N): _____

日期 (Date): _____

客户 CUSTOMER			承制方 MANUFACTURER		
品质 Quality	工程 Engineer	审批 Approved	审核 Checked	批准 Approved	销售 Sales

目 录 Contents

目 录 Contents.....	2
版 本 Version.....	3
1. 概 况 Profile.....	4
2. 可选镜头 Lens.....	4
3. 产品特性 Features.....	4
4. 应用范围 Application.....	5
5. 电气规格 Specifications.....	5
6. 可靠性测试 Reliability Testing.....	6-7
7. 结构图 Structural Diagram.....	8
8. 包装 Packing.....	9
9.外箱标签 Carton Box Mark.....	10
10.注意事项 Notes.....	10
11.命名规则 Naming Rule.....	11
12.配线 Accessory Cable.....	11

版本更改 Version

日期/Date	版本/Ver.	修改版本/Modification
2018-9-10	1.00	第一版 (The first version)

1. 概况 Profile:

JDPC70 1.00 CMOS 彩色摄像模组，采用 1/4inch CMOS 影像传感器。640*480 分辨率；适用于需要摄取视频信号的各种电子设备中，有 PAL 制式、NTSC 制式；具有自动白平衡，低照清晰，色彩饱和，中心点校正，低功耗；可以支持彩色转黑白, CVBS 输出。

JDPC70 1.00 CMOS camera module is comprised by 1/4" CMOS Image sensor. Resolution 640*480; It is applicable to various electronic devices that need to ingest video signals, including PAL system and NTSC system. With automatic white balance, low illumination clear, color saturation, central point correction, low power consumption; Can support color to black and white, CVBS output.

2. 可选镜头 Lens

可选 3.6mm , 2.8mm, 3.7mm 或其他客户指定的镜头。

Option 3.6mm, 2.8mm, 3.7mm or other lens which be specified.

3. 产品特性 Features

1. CVBS 视频输出 (1.0±0.2Vp-p/ 75 欧姆)

CVBS Video output (1.00 +0.2 Vp-p/ 75 ohms)

2. PAL 制式、NTSC 制式

PAL system, NTSC system

3. 自动白平衡、中心点校正

Automatic white balance, central point correction.

4. 应用范围 Application

- 办公室电子设备 Office electronic device
- 仪器、仪表和测量用具 Equipment & Instrument and measuring tools
- 机器设备 Machine equipment
- 监视设备（车用监视器、便携视频采集、远程监视）Supervising equipment (Car Monitor & Portable video capture and remote monitoring)
- 家居用品（可视门铃、可视电话）Home supplies (Video door phone & video phone)

5. 电气规格 Specifications

NO	项目/Item	参数说明/Specification		备注/Remark
1	图像传感器/Image sensor	1/4inch CMOS		
2	图像制式/Video Format	PAL		
3	有效像素/ Effective pixel	648H×480V		
4	同步方式/ Synchronously	内置同步/Built-in synchronization		
5	水平解析度/ Resolution	CVBS: 480TVL		
6	信噪比/ S/N ratio	45dB		
7	视频输出/ Video output	CVBS 1.0±0.2Vp-p/ 75 ohm		
8	白平衡/ White balance	自动白平衡/ Auto white balance		
9	帧率/Frame	CVBS:50field/sec (PAL) 60 field/sec (NTSC)		
10	启动时间/ Starting time	<500ms		
11	输入电压/ Input voltage	DC12V ±25%		极限范围+7V~+16V MaxRange+7V~+16V
12	功耗/ Power Consumption	DC+12V 电压时: 电流为 20mA±10mA DC+12V Voltage: current:20mA±10mA		
13	工作环境温度/ Working Temp.	-20℃ ~ 70℃		
14	储存环境温度/ Storage Temp.	-40℃ ~ 105℃		
15	湿度/ Humidity	5~95% RH		
16	图像显示方向/ Direction	拍摄正立图像时基板放置方位 Front Stand		
17	产品尺寸/ Dimension	32mm (L) × 32 mm (W)		
18	镜头参数/Lens Parameter	焦距 Focus	3.6mm	
		水平视角 horizontal view angle	54° ±3°	
		对焦距离 Focus Distance	40cm (近焦 Near) 1.5M (远焦 Far)	
		相对畸变 Distortion	<-6%	
		光谱特性 Spectrum	650nm 不感红外型 650nm without IR	

6. 可靠性测试 Reliability Testing

NO	试验项目 Testing Item	试验条件 Testing Conditions	判定标准 Judgment Standard
1	高温功能试验 High Temp. Test	+12V 通电, 高温 70°C; 8H 通电 +12V, high temp.70°C; 8H aging test	在 8H 测试中工作正常 Proper Functioning in 8H
2	低温功能试验 Low Temp. Test	+12V 通电, 低温-20°C; 8H 通电 +12V, low temp.-20°C; 8H aging test	在 8H 测试中工作正常 Proper Functioning in 8H
3	温湿度测试 Temp.& Humidity test	温度 70°C; 湿度 93%; 32H 通电 Temp.:70°C; Humidity 93%;32H aging	在 32H 测试中工作正常 Proper Functioning in 32H
4	高温贮存试验 High Temp. storage test	温度 105°C; 8H Temp.:105°C;8H	恢复常温后产品正常 Proper Functioning after test
5	低温贮存试验 Low Temp. storage test	温度-40°C; 8H Temp.: -40°C;8H	恢复常温后产品正常 Proper Functioning after test
6	寿命试验 Aging Test	12V 通电; 连续开关机; 48H 12V DC; Continuous on/off; 48H	在 48H 测试冲击中工作正常 Proper Functioning after 48H
7	间断电源试验 Discontinuous power supply test	常温下各输入 9V\12V\15V,5 秒循环开关机。每个电压通电 4H Input 9V\12V\15V,turn on/off in every 5s,test 4H for each voltage	每个电压冲击工作正常 Every Voltage works good after shock
8	静电放电试验 ESD test	接触放电 Contact discharge: 6.0KV 空气放电 Air discharge: 8.0KV 水平/垂直接触放电: 8.0KV Horizontal/Vertical discharge: 8.0KV	产品功能和外观无问题 Function and appearance are all ok
9	振动试验 Vibration test	1.振动标准: (1).振动方向: Y 方向 (2).振动幅度: 2mm (3).振动频率: 10HZ to 50HZ (4).振动表面: 紧靠一角的三个面 (5).振动时间: 30 分钟/每个面 1. Vibration standard: (1).Direction: Y direction (2).Range:2mm (3).Frequency:10HZ to 50HZ (4).Surface:1 surface fixed when testing another 3 surface (5). Time: 30mins./every surface	振动后,摄像机结构及功能应正常,所有配套附件及吸塑不出现异常现象 The camera structure &function working good after vibration, all accessories& blister have no change.

NO	试验项目 Testing Item	试验条件 Testing Conditions	判定标准 Judgment Standard										
10	跌落试验 Drop test	1. 跌落标准: (1). 跌落地面: 水泥地板或钢板 (2). 跌落方位: 一角、三边、六面 (3). 跌落方式: 自由下落 (4). 跌落高度: 根据产品的重量依照下表而定 1. Drop standard: (1). Floor: concrete floor steel plate (2). Direction: corner, three sides, six surface (3). Drop way: free falling (4). Height: according to the product's weight as follows: <table border="1" data-bbox="528 943 987 1167"> <thead> <tr> <th>重量 Weight</th> <th>高度 Height</th> </tr> </thead> <tbody> <tr> <td>0kg < W ≤ 4.5kg</td> <td>91cm</td> </tr> <tr> <td>4.5kg < W ≤ 11.8kg</td> <td>76cm</td> </tr> <tr> <td>11.8kg < W ≤ 23.1kg</td> <td>61cm</td> </tr> <tr> <td>23.1kg < W ≤ 45.4kg</td> <td>46cm</td> </tr> </tbody> </table>	重量 Weight	高度 Height	0kg < W ≤ 4.5kg	91cm	4.5kg < W ≤ 11.8kg	76cm	11.8kg < W ≤ 23.1kg	61cm	23.1kg < W ≤ 45.4kg	46cm	 跌落后, 摄像机结构及功能应正常, 所有配套附件及吸塑不出现异常现象 The camera structure and function is normal after dropped, all of accessories & blister are well.
重量 Weight	高度 Height												
0kg < W ≤ 4.5kg	91cm												
4.5kg < W ≤ 11.8kg	76cm												
11.8kg < W ≤ 23.1kg	61cm												
23.1kg < W ≤ 45.4kg	46cm												

7. 结构图 Structure Diagram

以下标注尺寸单位为: mm, 公差为±0.2mm(已标注公差除外)

Following size units are: mm, tolerance ±0.2mm(exclude marked)

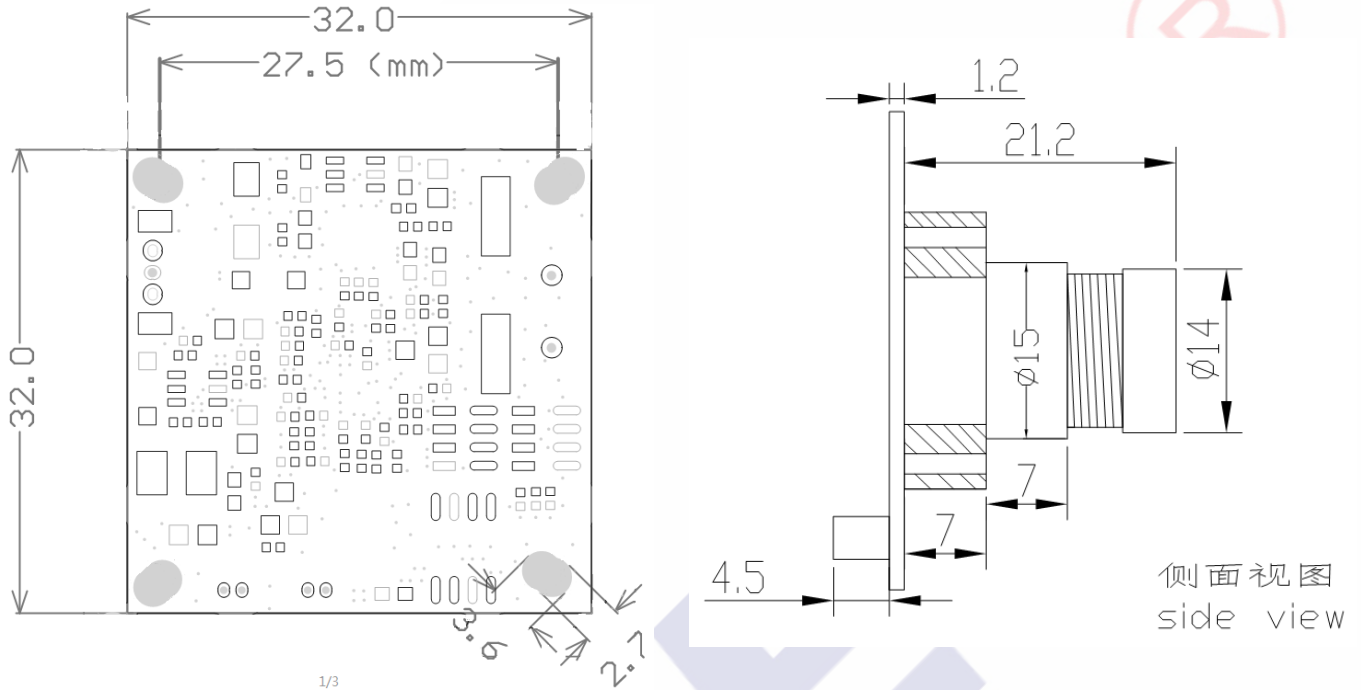

实物图/Picture of real products

正面 (front) :



背面 (reverse) :



VIDEO GND 12V

8. 包装 Packing

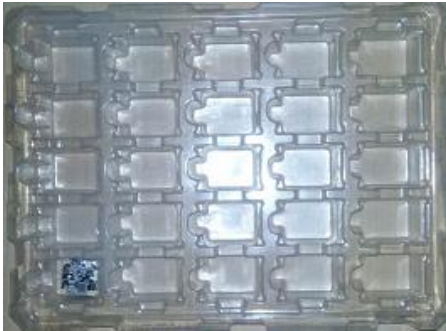

步骤 1: 将摄像模块放入吸塑盒中, 放满为止;

Step1: Put the camera module into the blister box until it is full.

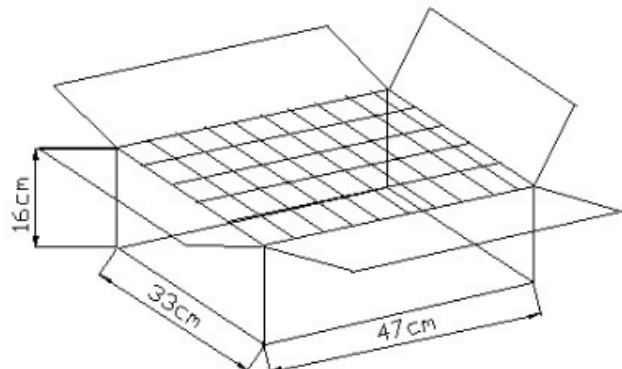
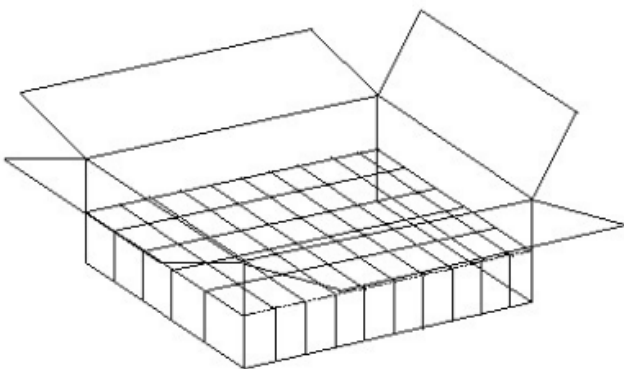

步骤 2: 将吸塑盒放入纸箱;

Step2: Put the blister box into the carton.

步骤 3: 逐层放入装有摄像模块的吸塑盒, 直到放满为止;

Step3 : Place the blister box with the camera module layer by layer until it is full.

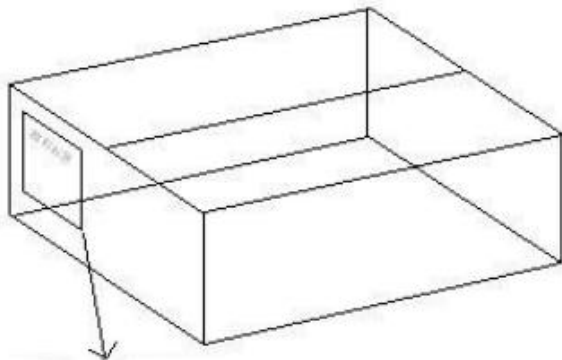

步骤 4: 检验员检验合格后放入合格证, 贴好物品标签并用胶纸封好纸箱。

Step4: After inspection, the inspector puts in the certificate of qualification, affixed the label of the goods and sealed the cartons with adhesive paper.

9. 外箱标签 Carton Mark

外箱标签的内容如下 The carton box mark include below information:

厂家码 Vendor Number :

订单号 Order Number :

物料规格 Part Specifications :

原料编号 Part Number :

生产日期 Production Date :

交货数量 Delivery Qty :

保障期限 Delivery Date :

备注 Remark :

10. 注意事项 Notes

- 1、输入电压请勿超过规格书上规定值以免损坏模组。

The input voltage don't exceed the value stated on the specification , in order to avoid damage to the module.

- 2、接口连接线不能接反，接反容易烧坏板子，对产品的使用造成影响。

The connector can't be reversed , reverse burn the board and affect the use of the product.

- 3、此驱动板为电子产品,所以加工、组装、操作时需注意防静电措施，以免影响产品性能。

This is a electronic product, so processing, assembly , operation need to take anti -static measures to avoid affecting product performance.

- 4、镜头是玻璃制品小心拿放，以免破裂。

Lens is glass product, place carefully to avoid breakage.

- 5、镜头是玻璃制品注意防尘、防损，以免影响图像较果。

Lens is glass-made product, please take anti-dust, loss prevention measures to prevent the image quality.

11. 命名规则 Naming Rule

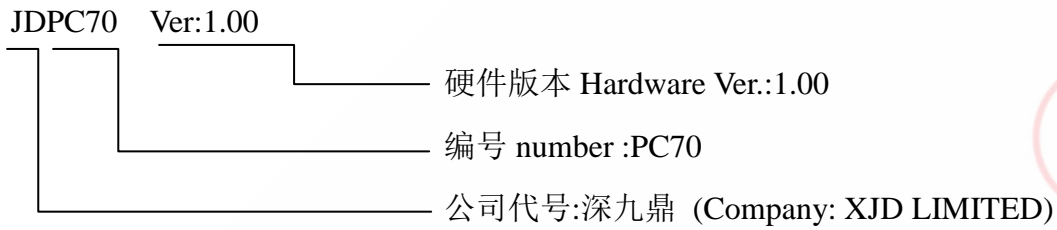

12. 配线 Accessory Cable

无配线

No Accessory