

# 产品规格书

## Specification

产品名称 (Product): 4.3 寸液晶存储模组/4.3inch Memory LCD Module

驱动板 (Driver board): JD43TDPR

版本号 (Version): VER:1.01

液晶屏 (TFT LCD): JD043C40D08A1-57ADT(43)

客户名称 (Customer): \_\_\_\_\_

客户型号 (Cust.P/N): \_\_\_\_\_

日期 (Date): \_\_\_\_\_

客户 CUSTOMER			承制方 MANUFACTURER		
品质	工程	审批	审核	批准	销售
Quality	Engineer	Approved	Checked	Approved	Sales

# 目 录 Contents

目 录 Contents.....	2
版本 Version.....	3
1. 概 况 Profile.....	4
2. 基本参数 Specifications.....	4-5
3. 产品图片 Product Picture.....	5
4. 连线示意图 Wiring Diagram.....	5
5. 驱动板接口定义 Interface Definition.....	6-16
6. 结构图 Structure.....	17-18
7. 产品标示 Labels.....	19
8. 包装运输 Packing Shipping.....	19
9. JD43TDPR 调试注意事项 Notes.....	19
10. 4.3"TFT- LCD PANEL 判定标准 Judgment.....	20-22



## 1. 概况 Profile:

JD43TDPR VER:1.01-JD043C40D08A1-57ADT(43)彩色存储驱动模组。由 JD43TDPR VER:1.01 存储驱动板和 (JD043C40D08A1-57ADT(43)) 屏组成。输入 CVBS (PAL) 信号,它具有拍照、录像、存储、支持图片全部删除、能对显示的时间及日期进行设置、同时对图像效果调整、掉电记忆、OSD 时间叠加功能,显示效果、时钟控制等都通过按键调节或 RS232 通讯串口发送命令, OSD 菜单显示。它主要用于可视门铃、楼宇对讲、可视电话等其他显示电子设备。

JD43TDPR VER: 1.01-JD043C40D08A1-57ADT(43) color storage drive module. It consists of JD43TDPR VER:1.01 memory driver board and (JD043C40D08A1-57ADT(43))screen. Input CVBS (PAL) signal, it has photo, video, storage, support for the deletion of all pictures, can set the time and date of the display, at the same time on the image effect adjustment, power-down memory, OSD time superposition function, display effect, clock control And so on through the button adjustment or RS232 communication serial port to send commands, OSD menu display. It is mainly used for visual doorbells, building intercoms, videophones and other display electronic devices.

## 2. 基本参数 Specifications:

No.	项目/Item	说明/Description	Note
1	液晶屏显示尺寸/LCD Display	4.3 英寸/4.3inch	
2	显示比例/Display Ratio	4:3	
3	背光方式/Backlight	LED	
4	亮度/Brightness	315~385cd/m2	
5	解析度/Resolution	480× 3(RGB)×272	
6	视角范围 View angle	(40/60/60/60) up/down/left/right	
7	液晶屏尺寸/LCD dimension	103.9 (W) ×81.3 (H) ×5.6 (D) mm	
8	有效显示范围/Effect area	95.04 (H) ×53.86 (V) mm	
9	驱动板尺寸/Driver board size	68.0 (W) ×62.0 (H) ×9.7 (D) mm	
10	工作电压 (纹波小于 0.3VP-P) Working Voltage (Wave<0.3VP-P)	最小: DC9V; 标准: DC12V; 最大: DC18V; Min:DC9V; Standard: DC12V; Max: DC18V;	
11	工作电流 (DC 12V 供电时) Working Current (DC 12V supply)	DC190mA±20mA	
12	消耗功率/Power Consumption	2.28W (TYP)	
13	启动时间/Start Time	≤2.0 秒 ≤2.0s	
14	工作温度范围/Working Temp.	-10℃~60℃	
15	储存温度范围/Storage Temp.	-20℃~70℃	

16	环境相对湿度/ENV. Humidity	5~95%RH	
----	----------------------	---------	--

注 1: 屏幕亮度值的测试结果, 采用 BM-7 仪器测试。

Note1: Brightness is tested by BM-7 testing machine.

### 3. 产品图片/Product Picture:



### 4. 连线示意图/Wiring Diagram:

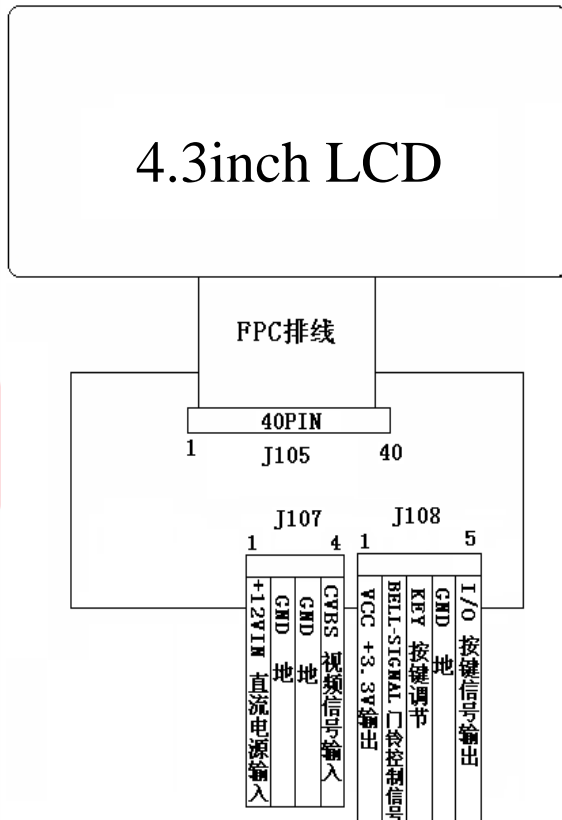

正面:

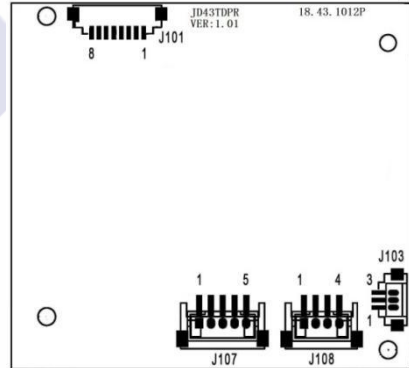

背面:

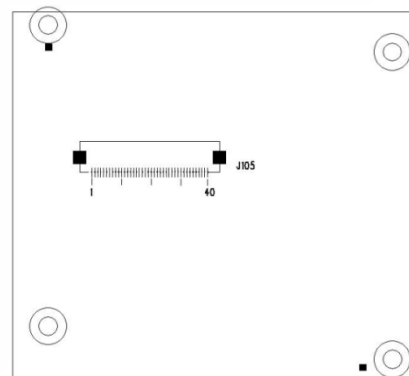

## 5. 驱动板接口定义/Interface Definition:

### 5.1. J108 接口定义/J108 Interface Definition: (4PIN 2.0mm):

PIN	Symbol	I/O/P	脚位定义说明/ Description	备注/Note
1	+12VIN	I	直流电源输入/DC power input	9~18V
2	GND	P	地/Ground	
3	GND	P	地/Ground	
4	CVBS	I	视频信号输入/Video signal input	0.6V-1.3V <sub>P-P</sub>

### 5.2. J107 接口定义/J107 Interface Definition: (5PIN 2.0mm)

PIN	Symbol	I/O/P	脚位定义说明/ Description	备注/Note
1	VCC	O	+3.3V 输出/+3.3Voutput	
2	EN	I	自动拍照/ Auto-photo	高电平时自动拍照 /The module will auto take photo when high voltage
3	KEY	I	按键数据输入/Key data input	
4	GND	P	地/Ground	
5	I/O	I	自定义/ User-defined	NC

**5.2.1. 按键板接线图/Wiring Diagram of keypad:**

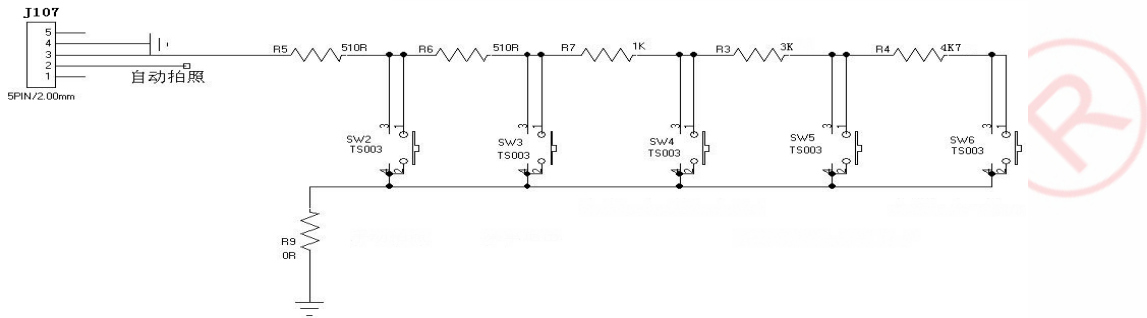

**5.2.2. 按键板顺序如下图所示/ The keyboard ordering as follows:**

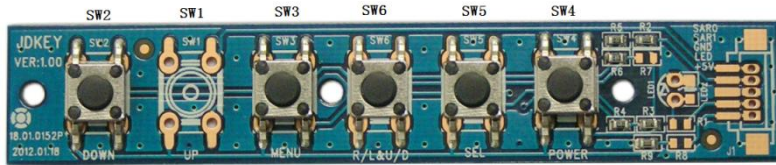

**快捷功能 / Keyboard function**

**SW3: 录像** 此按键可以实现录像功能，录像的格式是 AVI，目前单个录像最多可以录制 15 秒，录像保存在 TF 卡中，2G 的 TF 卡可以存放 137 段录像，录满 137 段之后会重复覆盖。最大存储录像的段数计算方法为： $(\text{TF 卡的容量}-512\text{MB})/10\text{MB}$ 。按键 SW2 退出录像。

**SW3: Record video** Press SW3 entry video record, the format is AVI, the max recording time is 15s for this version. The video is saved by TF card,2G TF card can save 137 section,video, it will be covered by new video section automatically when TF card is full. The max video section calculated method is:  $(\text{capacity of TF}-512\text{MB})/10\text{MB}$ . Press SW2 exit video.

**SW6:拍照** 此按键可以实现拍照功能。照片的格式是 JPG，照片同时可以保存在 flash 和 TF 卡中，4M 的 flash 可以保存 58 张照片，满 58 张之后照片重复覆盖。每拍 4 张照片自动备份照片到 SD 卡中，2G 的 TF 卡可以保存 515 张照片，存放满 515 张照片之后不会重复覆盖。4G 和 8G 的 TF 卡存放照片的张数最多 515 张。最大支持 32G 的 TF 卡。无论多少 G 的 TF 卡，最大存放照片的张数都是 515 张。

**SW6: Take picture** Press SW6 to entry picture record. The picture format is JPG, the picture can be saved in Flash and TF card. Max picture qty is 58pcs for 4M flash. The pictures will be saved in TF card automatically for every 4 pictures, max quantity for pictures is 515pcs for 2G or 4G or 8G TF card even 32G.

**SW5:录像播放** 此按键可以实现播放录像。在播放过程中, 按键 SW5 播放上一段录像  
按键 SW4 播放下一段录像, 按键 SW3 快进, 按键 SW6 暂停/播放, 按键 SW2  
退出播放。录像画面上显示第几段录像, 年/月/日, 小时/分钟/秒。

**SW5: Video replay** Press SW5 to entry video replay. When displaying, press SW5 to display last video, Press SW4 to play next video. Press SW3 Fast forward, press SW6 to Pause/Play. Press SW2 exit replay. LCD module will display video section number and date and time when replay.

**SW4 照片浏览** 此按键可以实现照片浏览, 在浏览过程中, 按键 SW5 浏览上一张照片,  
按键 SW4 浏览下一张照片, 按键 SW6 删除当前的这张照片。  
按键 SW2 退出浏览。照片上显示 第几张照片/照片总张数,  
年/月/日, 小时/分钟/秒。

**SW4 Browse picture** Press SW4 entry picture browse. When browsing, press SW5 to display last picture, press SW4 to display next picture. Press SW6 to delete existing picture. Press SW2 to exit browse. LCD module will display picture number/total pictures and date and time.

注: 新卡装上后录像会提示是否要格式化, 需选择是, 格式化一次 TF 卡。

Note: After assembled TF new card, it will indicate that whether need to reset or not, it needs press yes, it will be reset TF card.

注: 进入菜单模式后 10S 内无操作自动退出到直通模式, 有掉电记忆存储功能;  
进入录像后 10 秒钟退出 (定时); 增加外部拍照功能 (SAN 低电平有效)。

Note: When enter the OSD menu mode, no-operation after 10s, it will auto sign out to passing-mode, It supports power-off memory storage function.

Entering the video after 10 second, it will be signed out(timing),increase external photo function(SAN Active Low electricity).



### 5.3.3. 在直通模式下,按键 SW2 进入菜单界面(如图)/ Under normal mode, press SW2 entry this menu (below picture):

按键 SW6 和按键 SW3 分别进行左和右选择,  
Press SW6 and SW3 to left and right choice,

按键 SW4 和按键 SW5 分别进行上和下选择。  
Press SW4 and SW5 to Up and down choice.

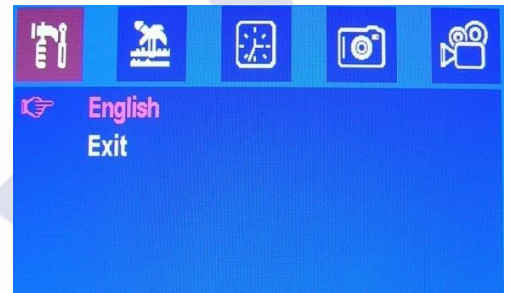
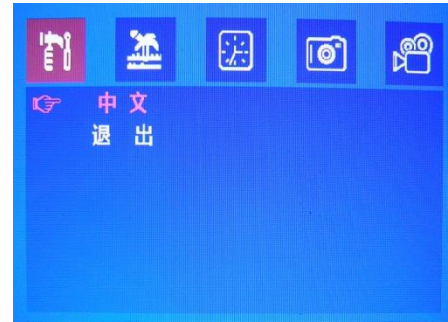

### 5.2.4. 语言选项界面(图 1)/ Language menu(Picture 1)

5.2.4.1. 两种语言可供选择: 中文和英文。

Two language : Chinese and English.

5.2.4.2. 中/英文选项:按键 SW2 进行中文和英文切换。

Chinese/English:Press SW2 for Chinese and English change.

5.2.4.3. 退出选项: 选择退出选项, 按键 SW2 退出语言设置菜单。

Exit: Choose Exit, press SW3 to exit menu.



图 1/Picture 1

### 5.2.5. 图像效果调节菜单（如图 2） / Parameter for picture adjust（Picture 2）

5.2.5.1、进入此选项可进行亮度、色度、对比度调节，每项调节范围都是从 0 到 100，默认值为 50。用户可根据个人需求进行图像效果调节。当切换到此菜单时，需按 SW4 或 SW5 确认，才能对数值和选项进行调节。

Entry this menu to adjust brightness and color and contrast, every adjust range is from 0 to 100, Default is 50. You can adjust the image according to the individual demand. When you setting this press, you need press SW4 Or SW5 to confirm, then you can adjust.

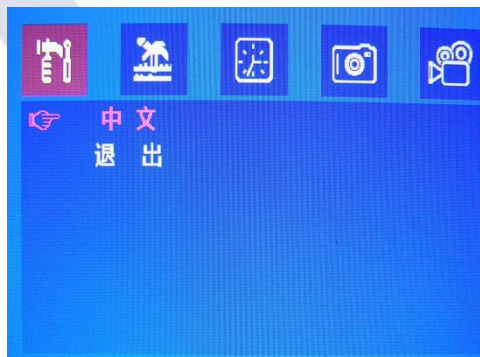
5.2.5.2、按键 SW3 和 SW6 分别进行数值加或减操作。

Press SW3 and SW6 to “+” or “-”.

5.2.5.3、按键 SW4 和 SW5 分别是选项向上和向下选择。

Press SW4 and SW5 are options up and down.

5.2.5.4、当选择“退出”选项时，按键 SW2 退出当前菜单。

When choose “Exit”, press SW2 to exit current menu.



图 2/Picture 2

### 5.2.6. 日期和时间设置菜单(图 3)/ Date and time setting（Picture 3）



图 3/Picture 3

当切换到此菜单时，需按 SW4 或 SW5 确认，才能对数值和选项进行调节

Press SW4 or SW5 to confirm, then start to adjust.

- 5.2.6.1、第一项是日期:格式是年、月、日（如 2014-01-16）。通过按键 SW3 和 SW6 来选择年、月、日三者中的其中一个。按键 SW3 和 SW6 分别是数值加和减。当设置好后，按键 SW2 切换到下一选项。

First is Date: example Year-Month-Date (eg:2014-01-16) , Press SW3 and SW6 to choose each of them. SW4 is up and SW5 is down. Press SW2 switch to next item after SW2.

- 5.2.6.2、第二项是时间:格式是小时、分钟。通过按 SW3 和 SW6 来选择小时和分钟两者的其中一个。按键 SW4 和 SW5 分别是数值加和减。当设置好后，按键 SW2 切换到下一选项。

Second item is time: format is Hour and minute. Press SW3 and SW6 to choose each of them.

SW4 is up and SW5 is down. Press SW2 switch to next item after SW2.

- 5.2.6.3、第三项是退出，当选择“退出”时，按键 SW2 退出当前菜单。

Third is exit: press SW2 when choose “exit”.

### 5.2.7. 拍照菜单(如图 4) / Take picture menu(Picture4)



图 4/Picture 4

当切换到此菜单时，需按 SW4 或 SW5 确认，才能对选项进行调节。

When switch to this menu, Press SW4 or SW5 to confirm to adjust after entry this menu.

- 5.2.7.1、查看选项：按键 SW2 进入照片浏览。在照片浏览过程中，按键 SW4 浏览下一张照片，按键 SW5 浏览上一张照片，按键 SW6 删除当前这张照片，按键 SW2 退出照片浏览。

Picture View: Press SW2 entry picture browse. SW4 display next photo, SW5 display last photo. SW6 to delete existing photo, SW2 to exit.

5.2.7.2、拍照选项:按键 SW2 进行拍照, 照片的格式是 JPG, 照片同时存储在 flash 芯片和 SD 卡中。4M flash 芯片可以保存 58 张照片, flash 中存放满 58 张照片之后会重复覆盖。每拍照 4 次 flash 中新照片自动备份到 TF 卡中, 2G 及以上的 TF (最大支持 32G) 最多可以存放 515 张照片, 满 515 张照片之后不会重复覆盖, 不再存放新照片。用户格式化或者在电脑上删除照片后又可以接着使用。

Take picture: Press SW2 for taking picture, format is JPG, Photos will be saved in flash chip and SD card at the same time.

5.2.7.3、删除选项:按键 SW2 删除掉所有的照片。

Delete All: press SW2 to delete all pictures.

5.2.7.4、格式化选项:按键 SW2 进入格式化界面, 按键 SW4 和 SW5 分别进行向下和上选择。按键 SW2 确认是/否格式化。如果选择格式化了, 那么 TF 卡中的数据会全丢失。 以下是提示用户是/否格式化界面。(如图 5)

Format: press SW2 entry format, press SW4 and SW5 to switch up or down options, press SW2 to confirm yes/no formatting. If choose formatting, All the data in the TF card is lost. The following is a prompting to prompt you whether formatting or not. (see picture 5).



图 5/Picture 5

5.2.7.5、备份选项: 按键 SW2 把所有的照片备份到 TF 卡中, 照片可以在电脑上打开。

Copy: press SW2 to back up all the photos to the TF card, the photos can be opened on computer.

5.2.7.6、当选择“退出”选项时, 按键 SW2 退出当前菜单。

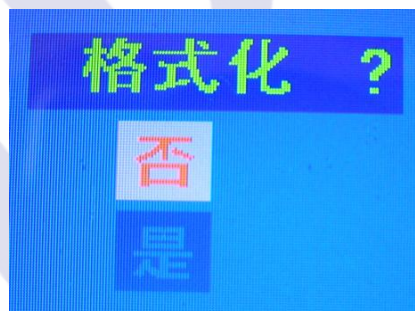
When choose “Exit”, press SW2 to exit the current menu.

## 5.2.8. 录像菜单 (如图 6)/ Record video (Picture6)



图 6/Picture 6

当切换到此菜单时，需按 SW4 或 SW5 确认，才能对选项进行选择。

When entry menu,if you want to choose options,you need to press SW6 or SW5 to switch up and down.

5.2.8.1、录像选项：按键 SW2 进行录像，录像的格式是 AVI，录像保存在 TF 卡中，录像可以在电脑中打开播放。目前单段录像最多可以录制 15 秒，15 秒之后自动保存退出。在录像过程中，按键 SW2 退出录像。2G 的 TF 卡可以录像 137 段，录满 137 段之后会重复覆盖。最大存储录像的段数计算方法为： $(\text{TF 卡的容量} - 512\text{MB}) / 10\text{MB}$ 。

Video menu: Press SW2 that recording video, format is AVI, it will save in TF card, and can open in PC. It can record 14s more or least in single video at present. After 14s, it will be auto save then exit. When recording, press SW2 that exit taking video. It can record 137segments for 2G, it will be repeated when full 137 segments. The methods of largest store video segments is  $(\text{TF's capacity} - 512\text{MB}) / 10\text{MB}$ .

5.2.8.2、播放选项:按键 SW2 进行播放 TF 卡中存储的录像，在不按其他按键的情况下，将顺序循环播放录像。按键 SW4 播放下一个录像，按键 SW5 播放上一个录像，按键 SW3 快进，按键 SW6 暂停和播放，按键 SW2 退出录像播放。

Play: Press SW2 to play videos. It will be loop playback without any other operation.

Press SW4 to play next video, press SW5 to play last video, Press SW3 to fast forward, to Press SW6 to Pause/Play. Press SW2 to exit.

5.2.8.3、格式化选项:按键 SW2 进入格式化界面，按键 SW4 和 SW5 进行向下和上下选择；按键 SW2 确认是/否格式化。如果选择格式化了，那么 TF 卡中的数据会全部丢失。下图是提示是/否格式化界面(如图 7)。

Resetting/Formatting options: Press SW2 which can enter resetting up page, press SW4/SW5 is UP/DOWN options, Press SW2 to confirm whether reset or not, if press yes, so all datasheet will be lost.



图 7/Picture 7

5.2.8.4、时间: 当选择“退出”选项时, 按键 SW2 退出当前的菜单。

Time: When choose “exit” option, press SW2 to exit current page.

**5.3、J103 接口定义/J103 Interface Definition: (3PIN 1.25mm)**

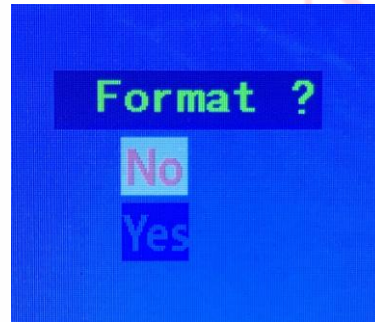
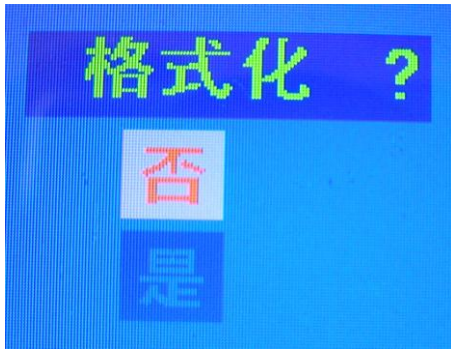
序号	脚位定义	I/O/P	脚位定义说明/PIN Definition	备注/ Note
1	RX	I	RS232 数据接收/ RS232 Data Receiving	
2	TX	O	RS232 数据发送/ RS232 Data Sending	
3	GND	P	地/Ground	

**5.4、J105 接口定义/ J105 Interface Definition: (40PIN 0.5 mm)**

No	Symbol	I/O/P	Description	Remark
1	LED_Cathode	p	LED_Cathode	
2	LED_Anode	p	LED_Anode	
3	GND	P	Ground	
4	VDD	P	power supply (3.3V)	
5	R0	O	Red data	
6	R1	O	Red data	
7	R2	O	Red data	
8	R3	O	Red data	

No	Symbol	I/O/P	Description	Remark
9	R4	O	Red data	
10	R5	O	Red data	
11	R6	O	Red data	
12	R7	O	Red data	
13	G0	O	Green data	
14	G1	O	Green data	
15	G2	O	Green data	
16	G3	O	Green data	
17	G4	O	Green data	
18	G5	O	Green data	
19	G6	O	Green data	
20	G7	O	Green data	
21	B0	O	Blue data	
22	B1	O	Blue data	
23	B2	O	Blue data	
24	B3	O	Blue data	
25	B4	O	Blue data	
26	B5	O	Blue data	
27	B6	O	Blue data	
28	B7	O	Blue data	
29	GND	P	Ground	
30	DOT CLK	O	Data Clock	
31	DISP	O	Sstandby mode control pin	
32	HSYNC	O	Horizontal Synchronous Signal	
33	VSYNC	O	Vertical Synchronous Signal	
34	DEN	O	Data enabling signal	
35	NC	-	No Connect	
36	GND	P	Ground	
37	XR	I/O	Right electrode - differential analog	
38	YD	I/O	Bottom electrode - differential analog	
39	XL	I/O	Left electrode - differential analog	
40	YU		Top electrode - differential analog	

## 5.5、驱动板 J101 接口定义/ J101 Interface Definition:(8PIN 1.25 mm)

### JD-TFCON 板接口定义/JD-TFCON Interface Definition:(9PIN 1.25 mm)

驱动板 J110		JD-TFCON 小板 J201	
序号	脚位定义	序号	脚位定义
1	SD-D1	1	TF-D2
2	SD-D0	2	TF-D3
3	GND	3	TF-CMD
4	SD-CLK	4	+3.3V
5	SD-VCC(3.3)	5	TF-CLK
6	SD-CMP	6	GND
7	SD-D3	7	TF-D0
8	SD-D2	8	TF-D1
		9	Cd(空)

注：此接口为外接 TF 卡座小板时使用，内置 TF 卡座时不使用此接口。

TF 卡的读写速率应采用 class6 以上的读写速率。速率越高录像效果越好，播放录像时越流畅，掉帧会越少。录像时间固定为 15S，也可以跟据客户需求修改 10s、20s、30s 或者是长时间录像，但是录像的段数是以最长录像时间来计算。

Note: TF card should be used to above class6 rate of reading and writing, more higher rating, the recording more better.Video more smoothly, frame will be less, the recording time fixed 15s,it can customized to 10s/20s/30s as per demands.





6.2. PCB 尺寸/PCB size: 68.0(W)×62.0(H) ×9.7(D) mm

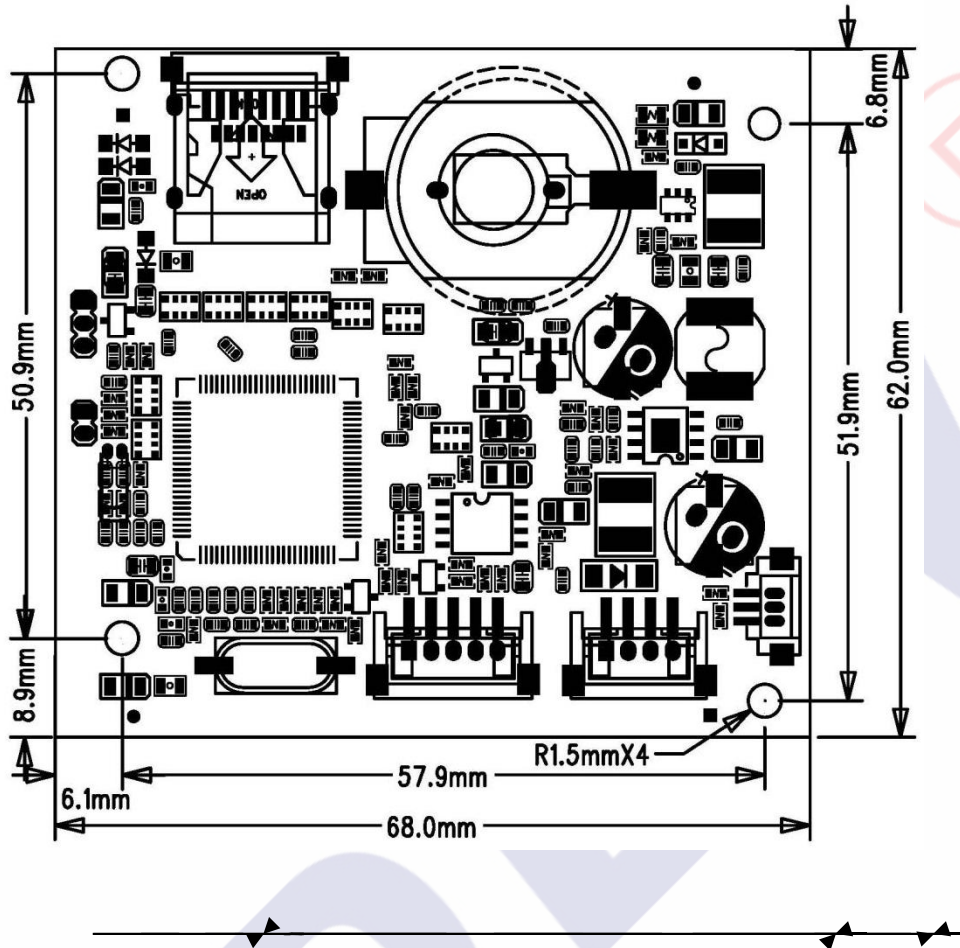

## 7. 产品标示/Product Label:

JD043C40D08A1-57ADT(43)

## 8. 包装、运输及贮存/Packing Shipping

### 8.1. 供货包装/Packing

TBD

### 8.2. 运输及贮存/Shipping

运输过程避免碰撞和雨雪淋袭；严禁与化学物品及潮湿物品同库贮存。

Don't hit and rain when transportation: Don't storage with chemic goods and wet goods together.

## 9. JD43TDPR 调试注意事项/Notes

9.1. TFT 出厂前已用专用仪器进行精密调试和老化、测试，一般不需要再做调整。

TFT have used by special instrument to adjust precision and aging, test before leave factory, no need adjust again.

9.2. 调整前，应正确连接电源、视频信号，应数次开关电源以及视频信号检查图像情况。

Please correctly connect power, video signal before you adjust, should be on/off power and video signal to check the image's effect.

9.3. 因为此产品为电子产品，请注意防静电。

Due to this product is electronic product, please notice prevent static.

9.4. 4.3"TFT- LCD PANEL 为玻璃制品，小心拿放，以免破裂。

4.3"TFT-LCD Panel is a glasswork, place carefully ,broken for fear

9.5. 4.3"TFT- LCD 面板与驱动板之间通过"FPC"排线连接, 请小心操作, 以保证功能正常。

The connection is "FPC", which connects 4.3"TFT-LCD panel with PCB, Please operates it carefully, in order to keep it well.

9.6. 按按键时需注意不能让手碰到按键引脚，因人体有一定的电阻，如触摸到会对按键功能造成影响。

Don't touch pushbutton's pin feet when you adjust potentiometers, due to person have resistance, you will effect pushbutton's function when touch it.

## 10. 4.3"TFT- LCD PANEL 判定标准/Judgment:

目的: 制定 PANEL 的标准供进料检查、制程检查、客户检查的依据.

Aim: Make the panel standards to material purchasing, process inspecting and customer checking.

范围: 适用于 4.3"TFT LCD 产品.

Ranges: apply to 4.3"TFT LCD modules

作业内容/ Determinant standard and method:

### 10.1. 判定标准及方法:

Judgment standard and method:

#### 10.1.1. LCD 显示屏伤痕检测方法 with 判定:

The method and determinant of inspecting the nick of panel of LCD:

在 20W 萤光灯下, 距离 PANEL 30CM 处垂直 (或左、右 45 度) 观察, 如果没有看见异物、伤痕, 则判定 OK, 否则 NG.

Inspect vertically (or at 45° angle from left/right) under the light tube (the power is 20 W) in the distance of 30cm to the panel. If there is no nick, it determines "OK", otherwise "NG".

#### 10.1.2. LCD 显示屏黑点, 白点, 色点检测方法 with 判定:

The method and determinative for black & white & color spots for the Panel of LCD:

### 1. 检查方法/Inspection Method:

黑点: 在表示点灯状况下, 把检查黑点的 MASK 摆在 LCD 黑点的附近, 目视观察比较大小.

Black spots: under the situation of "turn on the light", set the MASK of black spot inspection near the black spot then compare the big and small by eyes.

白点, 色点: 在表示点灯状况下, 把检查黑点的 MASK 重叠在 LCD 白点 (色点) 处, 目视观察判断白点 (色点) 否可以隐藏.

White & Color spots: under situation of "turn on the light", set the Mask of black spot inspection on the white spot (or color spot) then observe them by eyes if it can hide.

2. 显示屏区域划分/Division of LCD Panel:

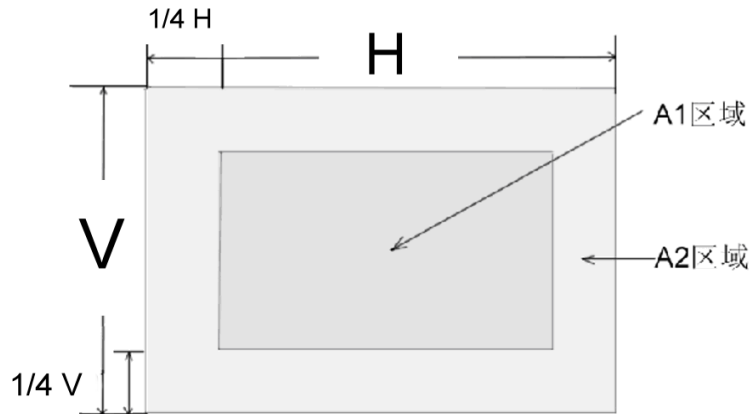

注/Note: A1 区域: 图像有效区域中心范围.

A1 area: The center of the available area for the picture

A2 区域: 图像有效区域边缘范围 (四周的区域)

A2 Area: The edge of the available area for the picture

10.1.3 判定选择/ Determinant Choice:

欠点直径 (mm) Spot Diameter		允收范围/Accept Range	
		A1 区域/A1 area	A2 区域/A2 area
黑点 Black spot	$d \leq 0.15$	不计/Disregard	不计/Disregard
	$0.15 < d \leq 0.3$	4	4
	$0.3 < d \leq 0.5$	2	3
	$0.5 < d < 0.8$	0	2
白点或色点 White spot or Color spot	$d \leq 0.15$	不计/Disregard	不计/Disregard
	$0.15 < d \leq 0.25$	3	3
	$0.25 < d \leq 0.3$	1	2
	$0.5 < d < 0.8$	0	1

## 注/Note:

1. 大小: 平均直径= (最长直径+最小直径) /2

Size: Average Diameter= (Max. Diameter + Min. Diameter) /2

2. 关于小欠点密集的时候, 用上述的基准判断。

Using information above as a standard in order to judge while the e spots are dense.

3. 黑斑、白斑: 通过电压的变化来看, 用对比的方法, 对于明显斑点用点规格判断。

Black & White spot: To judge the obvious spots through the change of voltage by comparison.

4. 总的黑点、白点、色点个数: A1+A2 区 ≤4 个。

Total quantity of Black & white & color spot: A1+A2 ≤4.